



Plans for the GridPix Modules

J. Kaminski for the GridPix groups of
Bonn, Nikhef and Siegen

Gating WS, DESY, 3.11.2016

Remarks to last test beam

Chips operational in the test beam

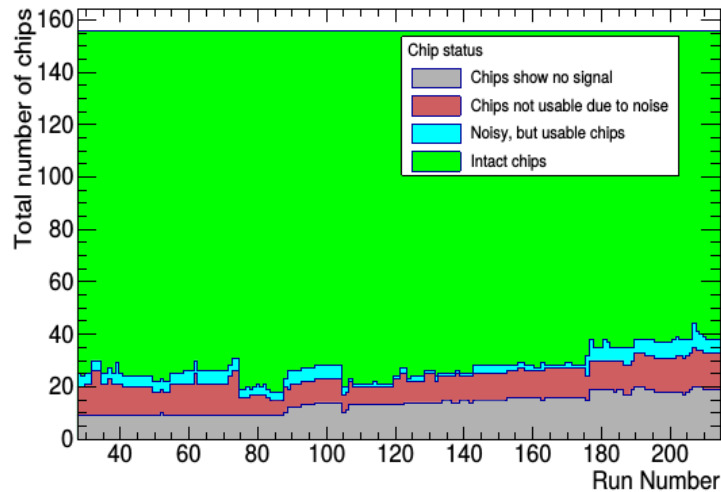

A number of GridPixes died during the test beam because of defects in the protection layer
 → problem identified and solved

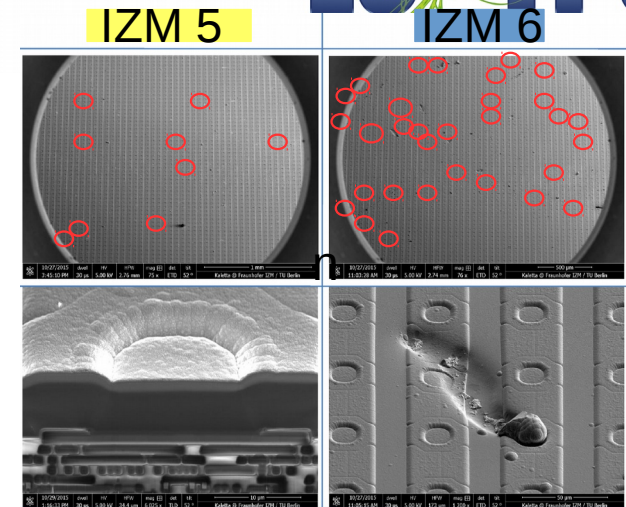

New production batch (IZM-7) shows no defects and seems to be discharge proof.



4 GridPixes were tested in a constant discharge modes at $U > 400$ V. Example:

- W0065-F2: $t_{400} = 105$ min, $t_{450} = 65$ min & $t_{500} = 95$ min
 $\Rightarrow \sim 2.1 \times 10^6$ sparks in ≈ 265 min
- W0069-E2: $t_{400} = 115$ min, $t_{450} = 135$ min, $t_{500} = 145$ min & $t_{550} = 25$ min
 $\Rightarrow \sim 4.0 \times 10^6$ sparks in ≈ 420 min

Discharges did not degrade the performance of the GridPixes (energy resolution).

GridPix on Timepix-3



Timepix-3 has been produced. Most important improvements:
Charge and time are available for every pixel,
Multi-hit capable,
Very high output rate: 8×640 MHz (self triggering),
Better time resolution (~1.7 ns)

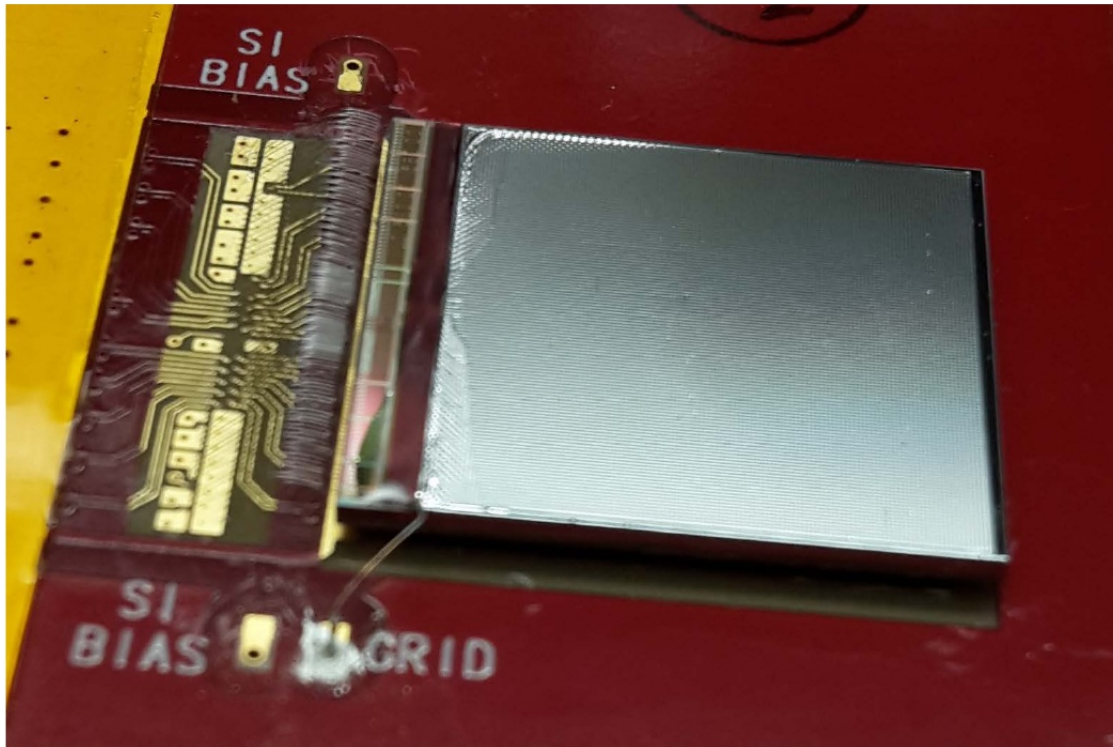

InGrids were built on top of Timepix-3.
Some improvements were done to the design:
The dykes at the borders were reduced and moved to the outside => the active area was increased.
Now 256x250 pixels are covered by grid.

First Tracks and Laser Spots!!!

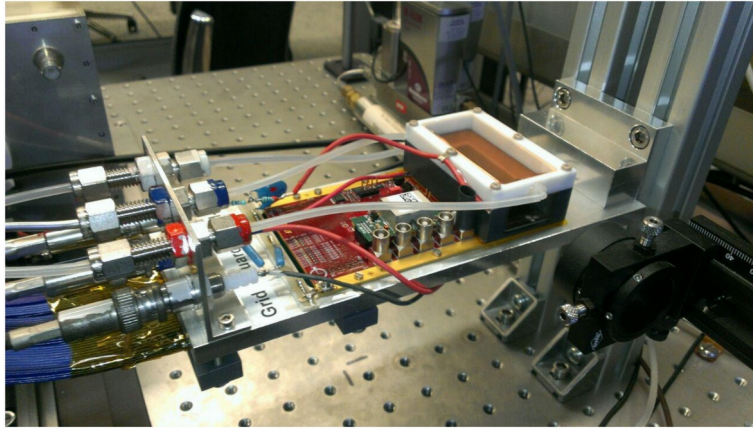

Small detector with a few mm drift distance was built at Nikhef

- First muon tracks were observed
- A laser is used to scan the active area and check the performance over the complete area

Muon track

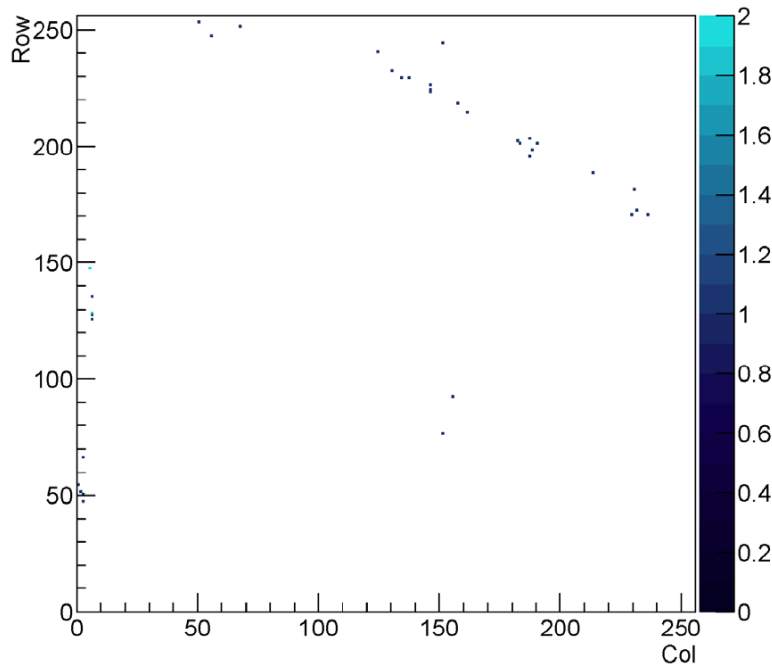

TimePix-3

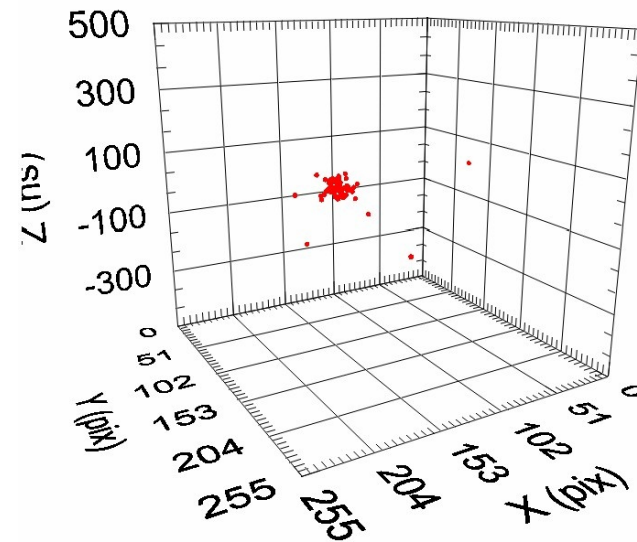

New Quad Design



Design optimized to have the best space coverage possible ($> 80\%$)
Readout is done by SPIDR of Nikhef.

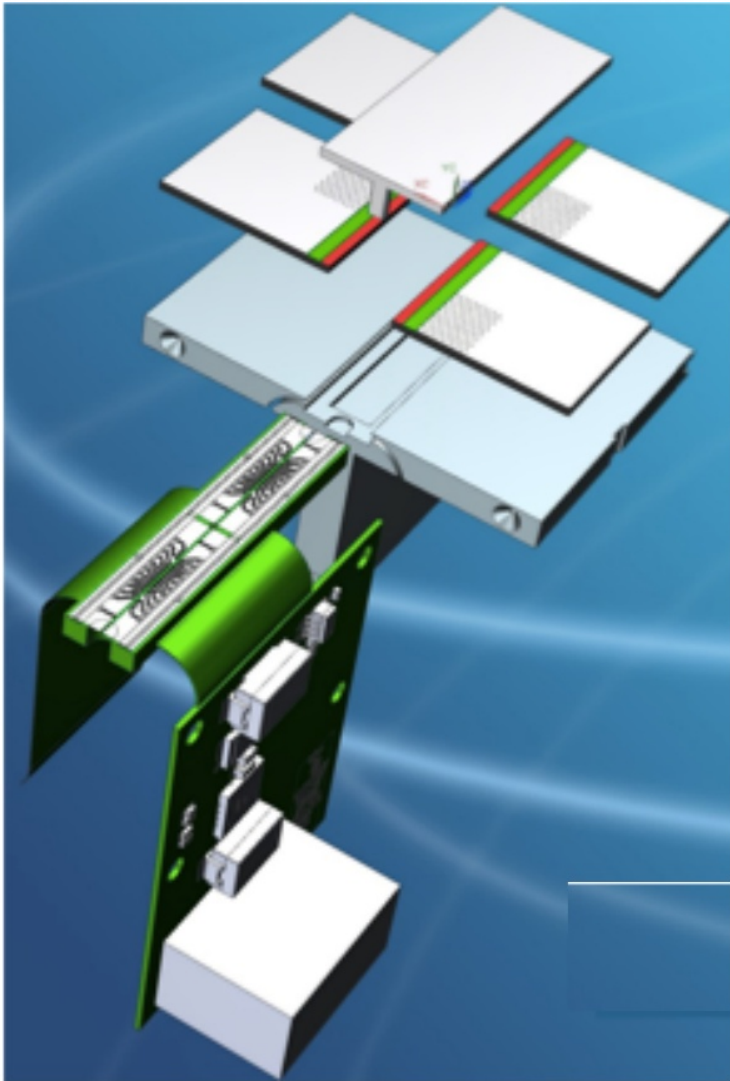

Auke Korporaal, Bas van der Heijden
Charles Ietswaard

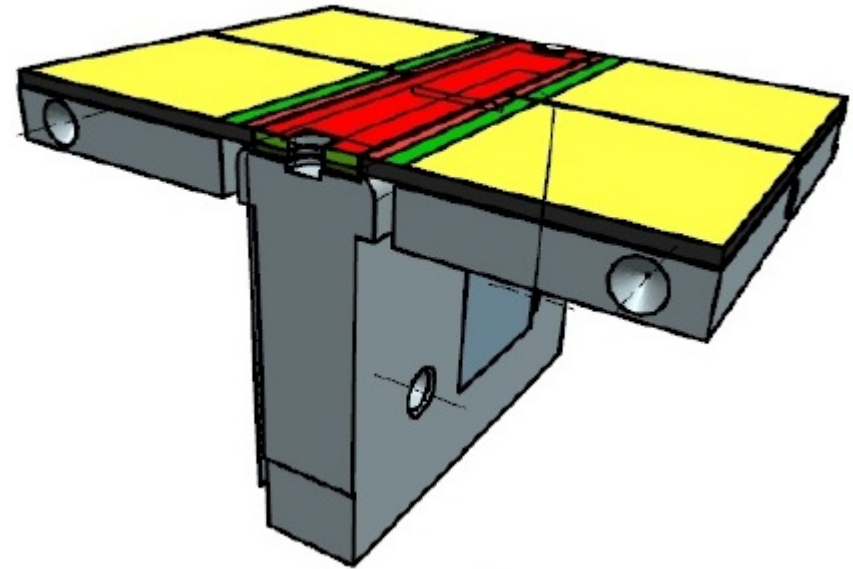

Next Modules



Current plans for ext modules:

- A first quad module should be ready at the end of 2016
- This will be first tested in smaller detectors
- Then a module with 1 or 2 quads will be built next year.
 - Test beam mid to end of 2017
- Then a complete module O(100 GridPixes) is planned
This module should be as close to the final design as possible to make final measurements for the technology decision.
 - Gating GEM should be included